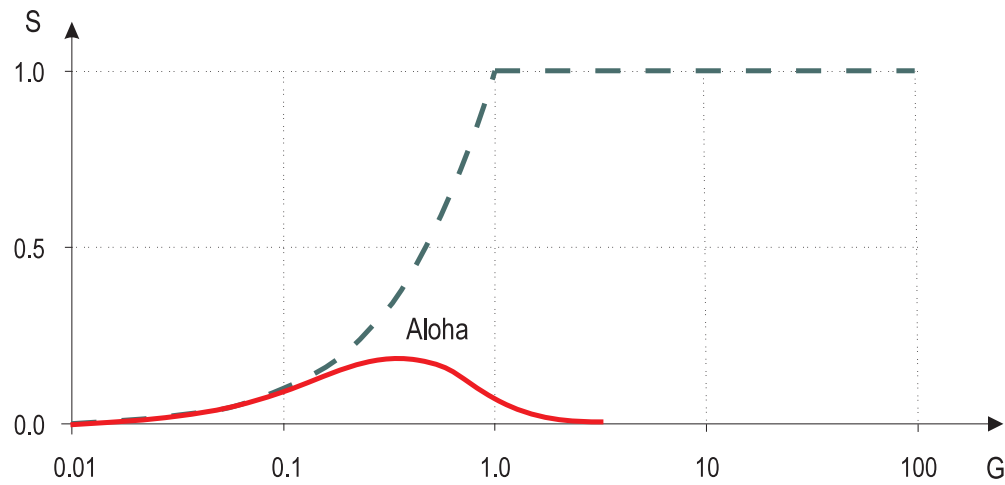
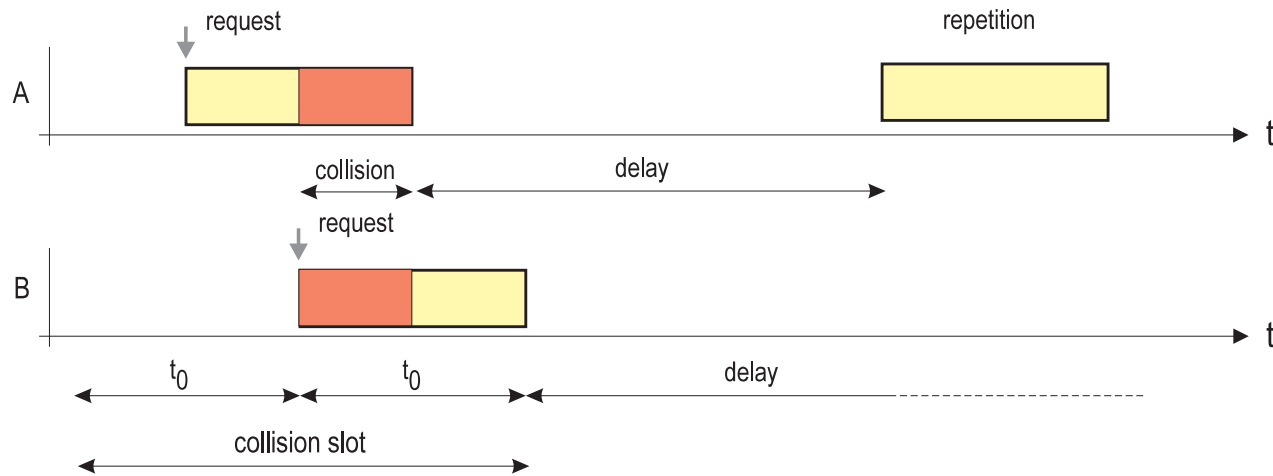

Lokální síť (03)

Jan Janeček

katedra počítačů

České vysoké učení technické v Praze

Aloha



Taktovaná Aloha

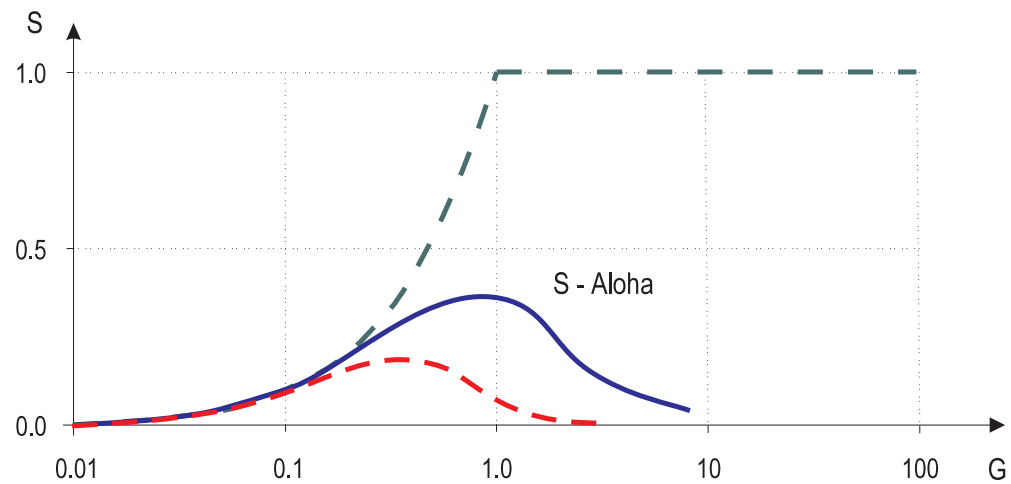
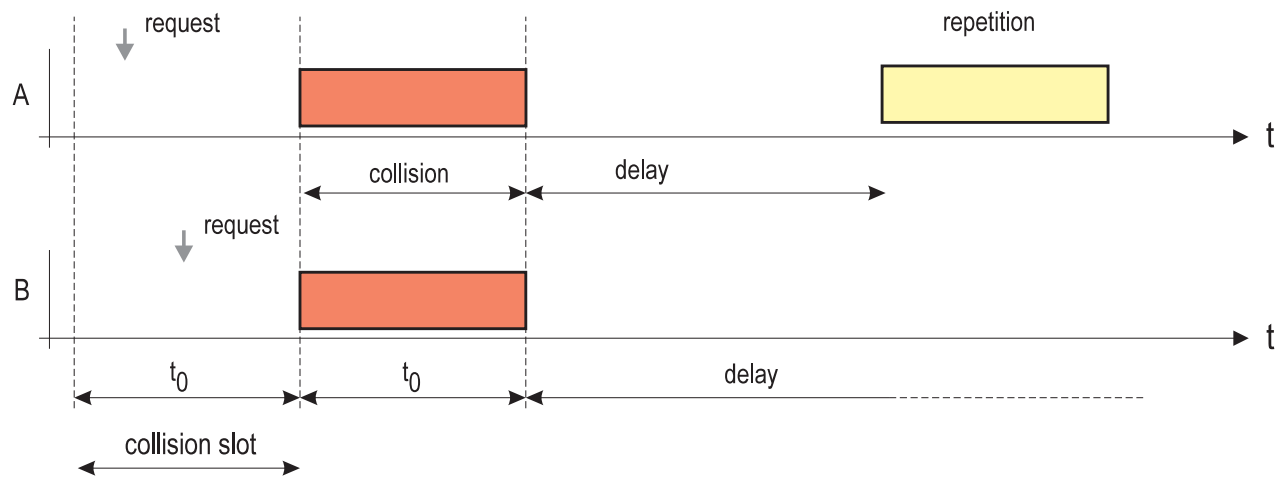

Stabilita

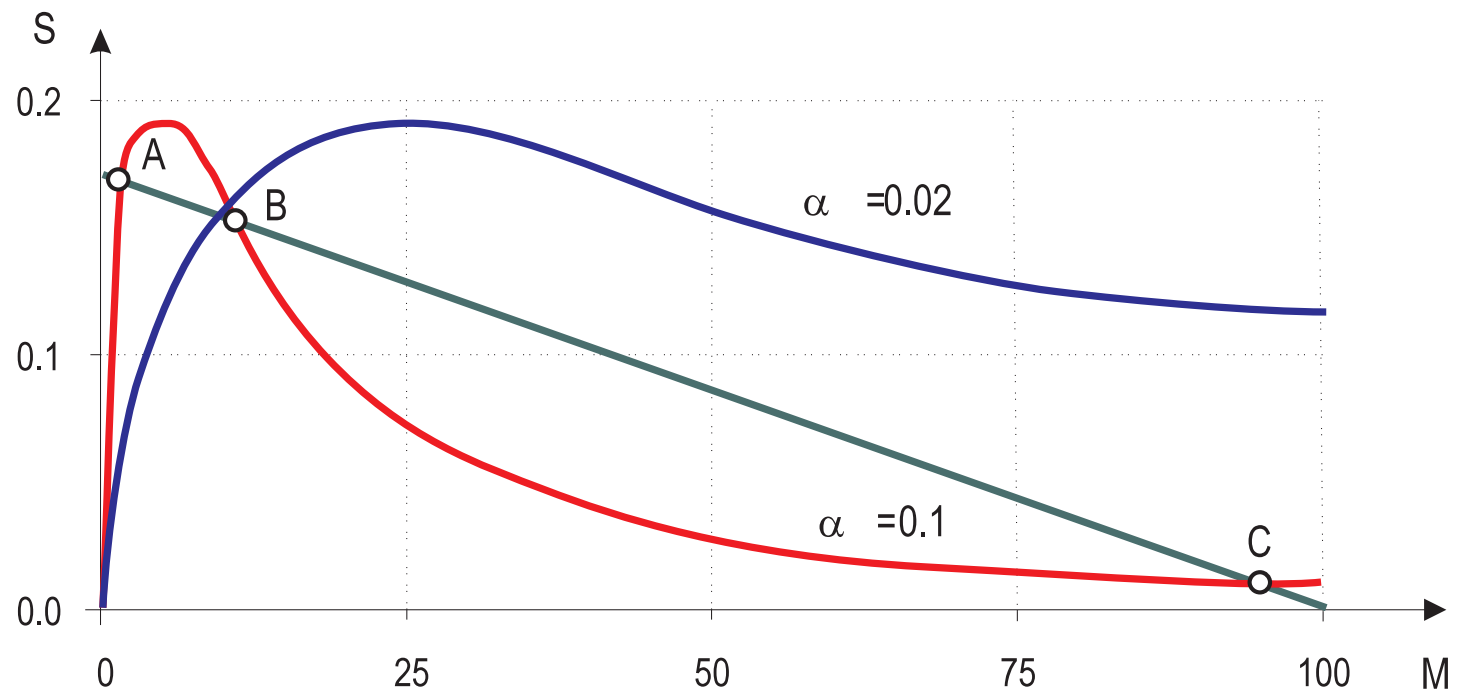

Naléhající CSMA

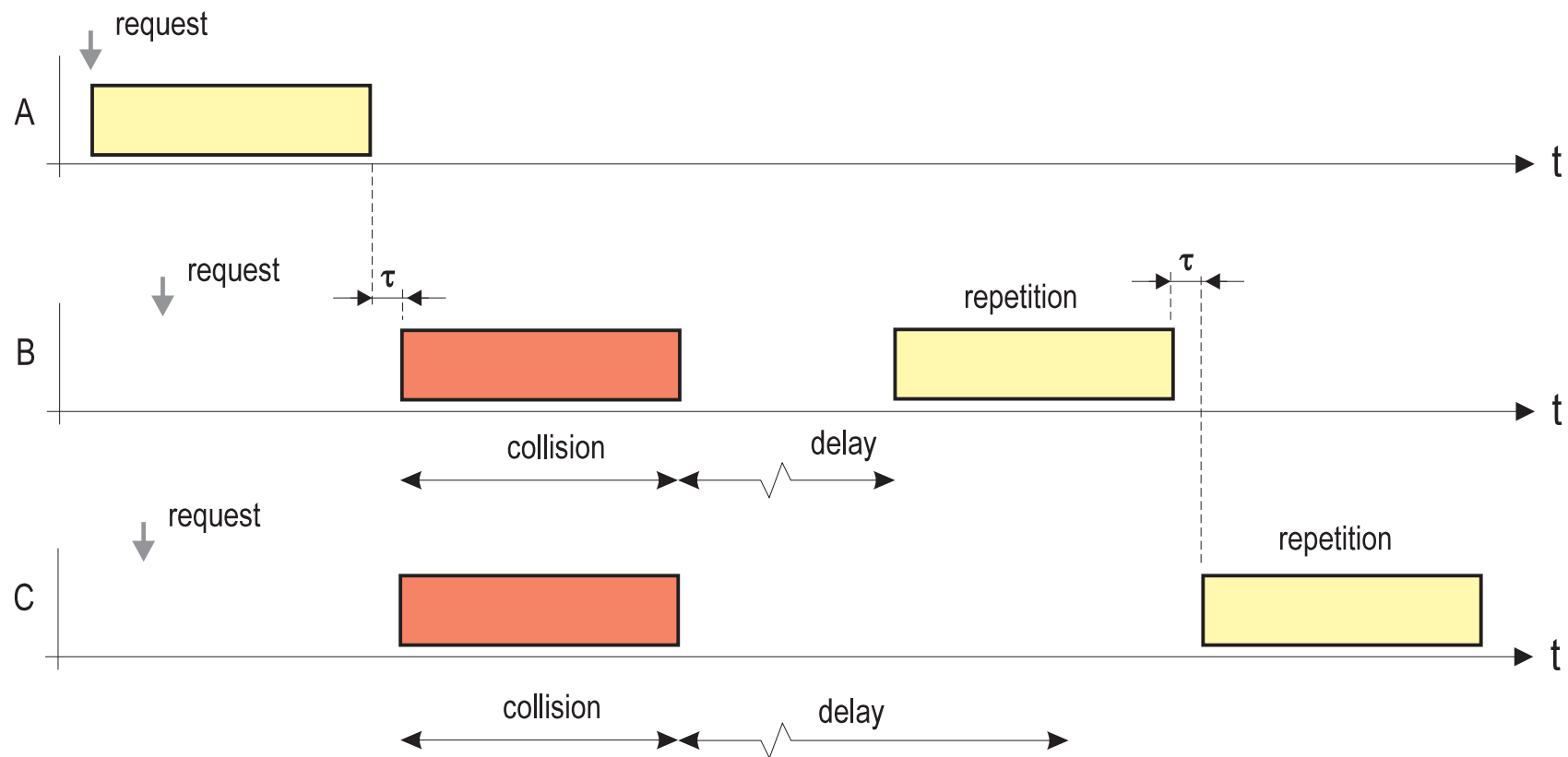

Nenaléhající CSMA

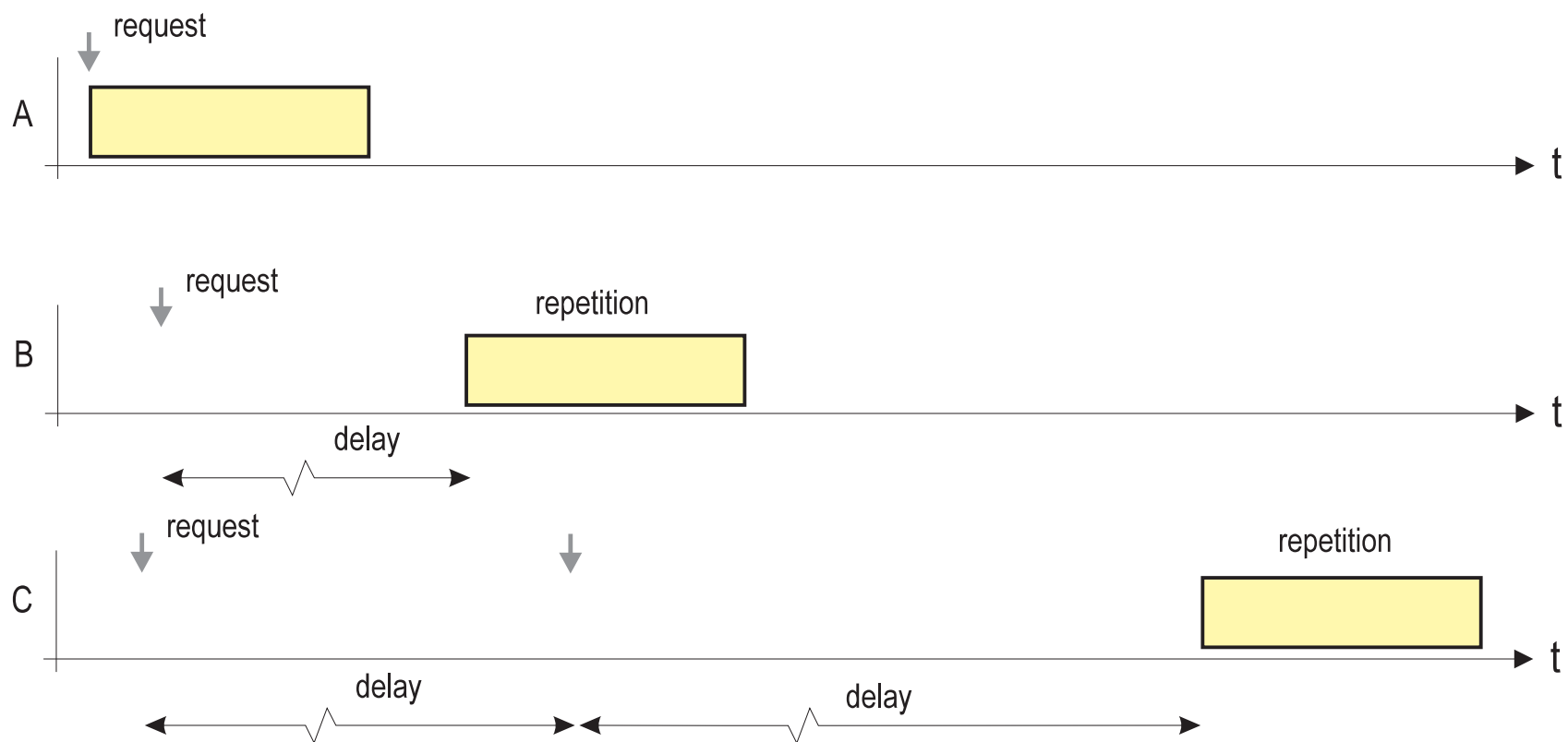

p-naléhající CSMA

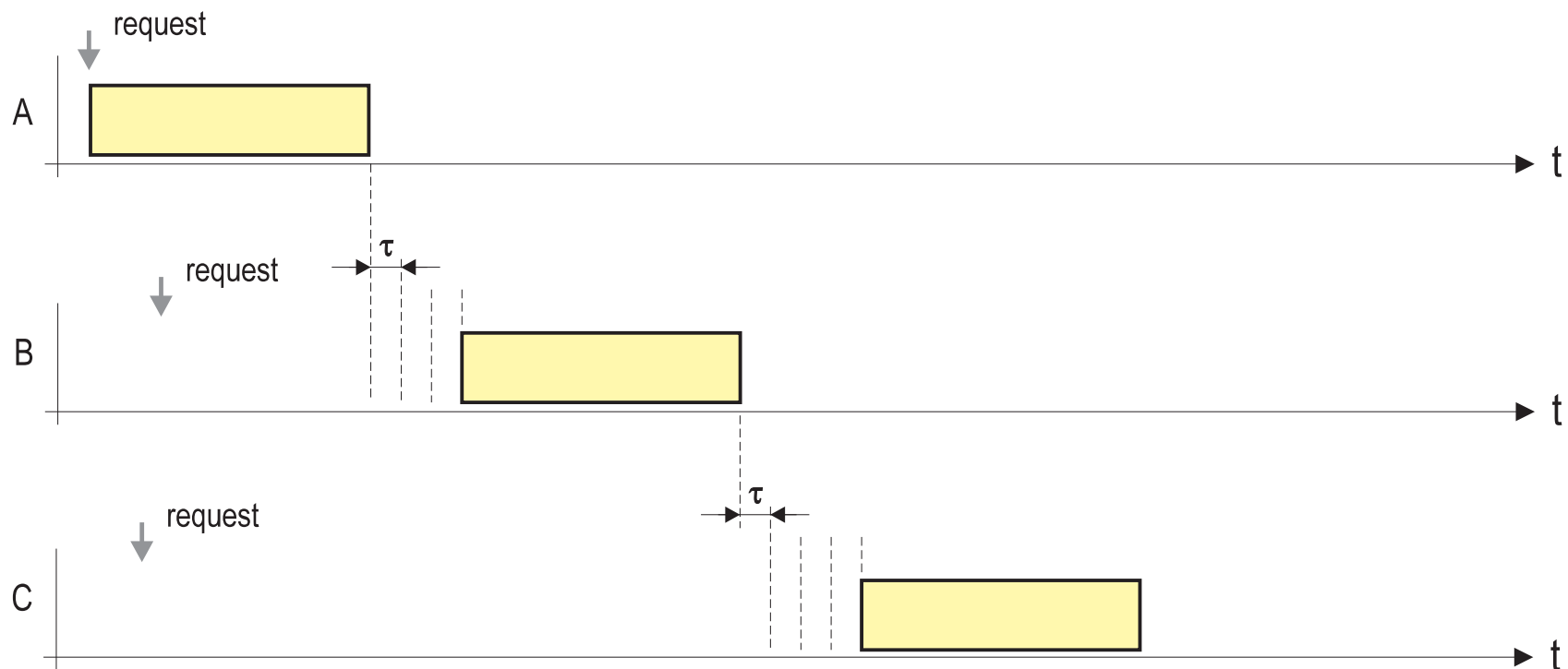

Průchodnost kanálu

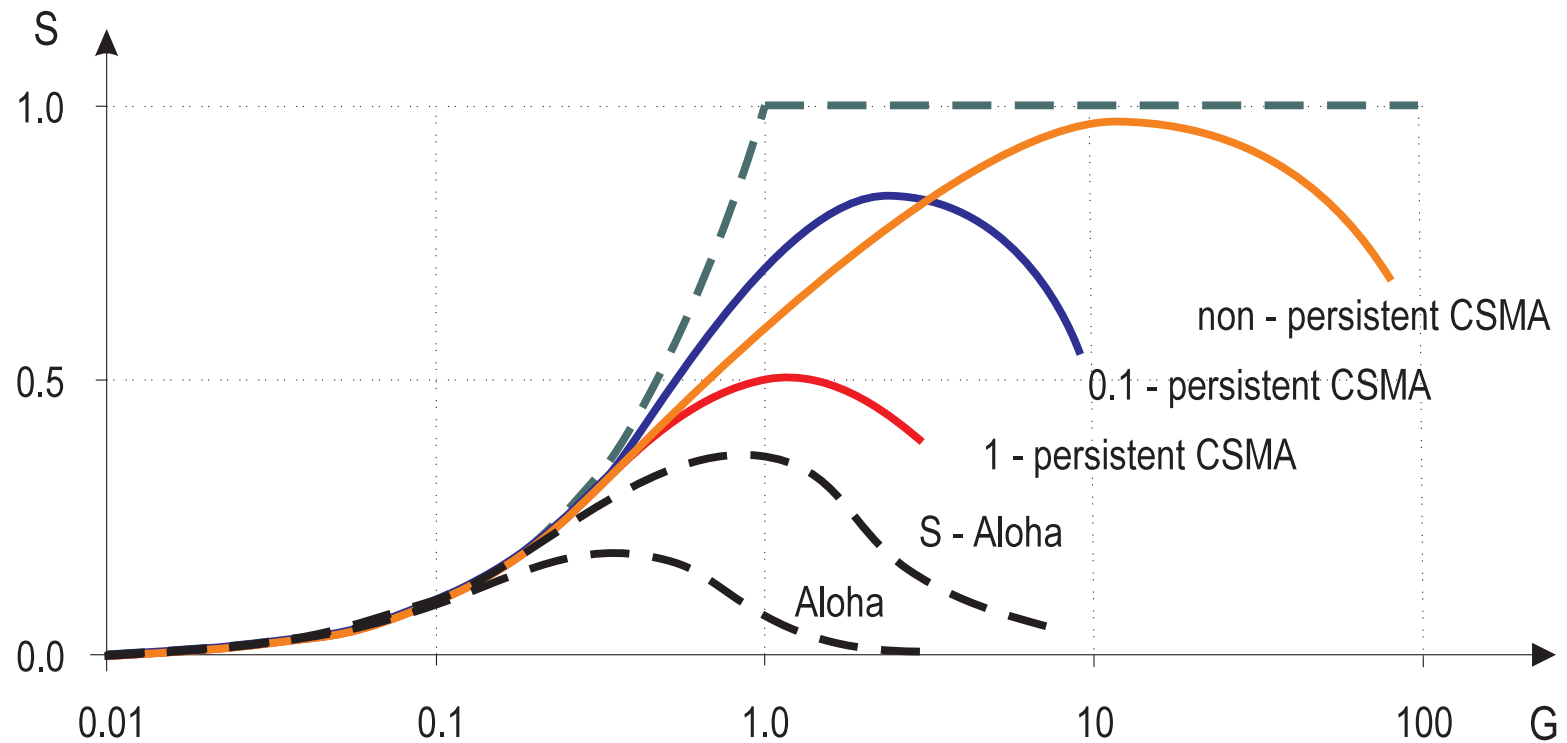

Zpoždění přenosu

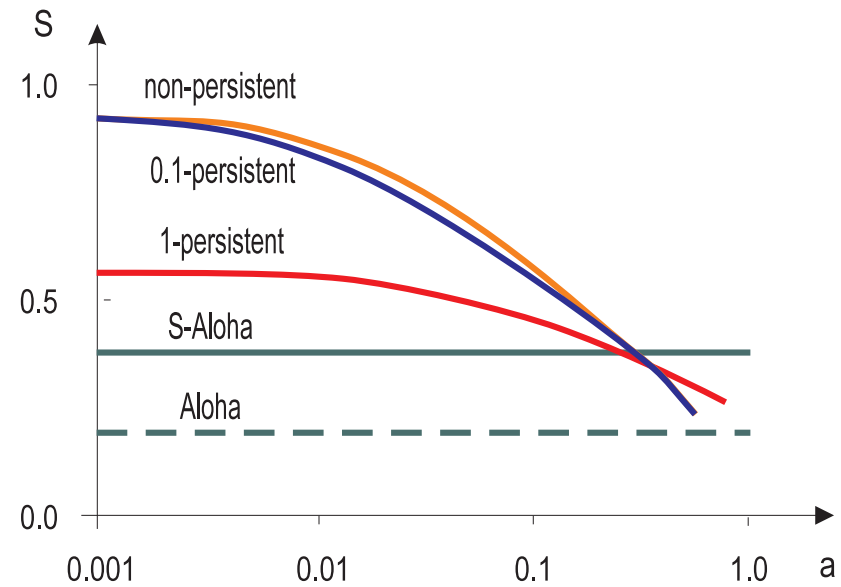
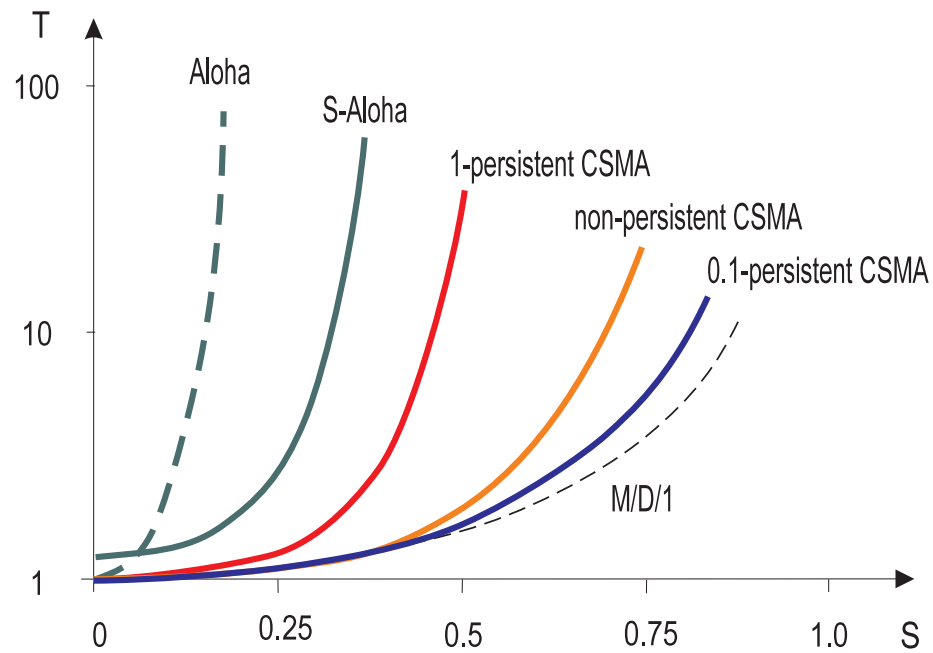

CSMA/CD

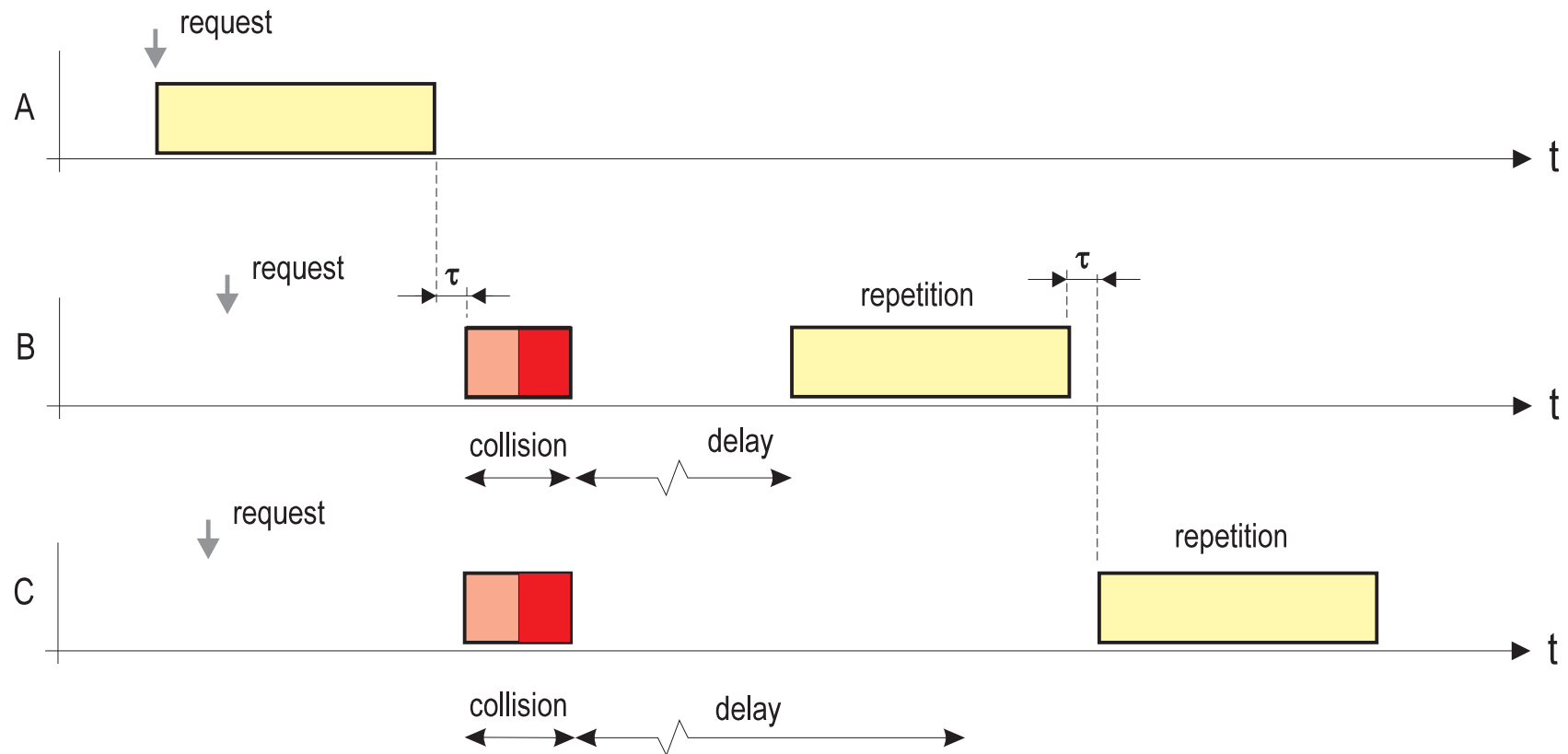

Ethernet I

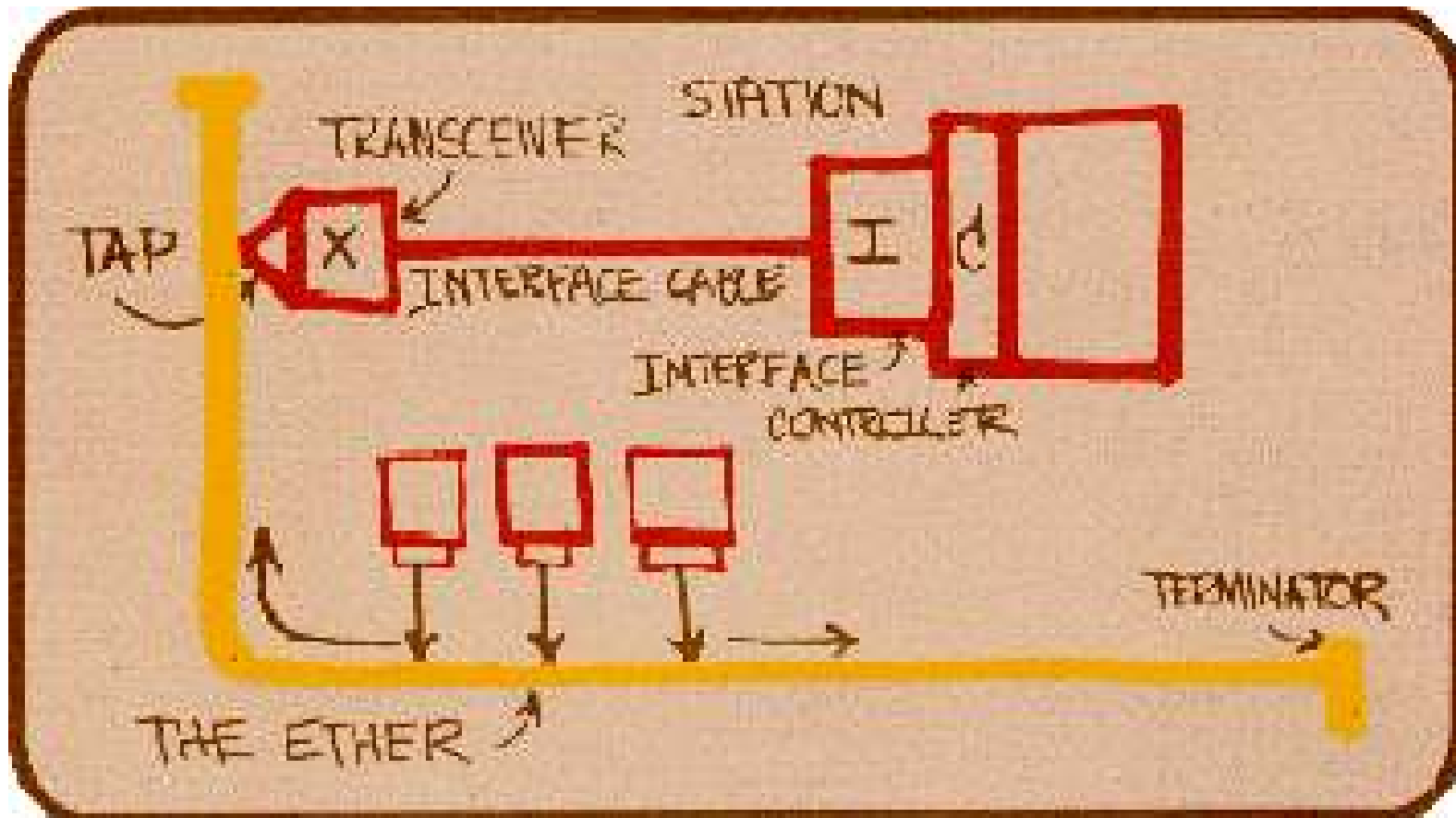

Ethernet II

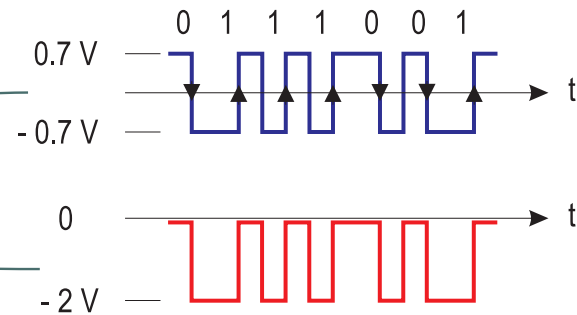
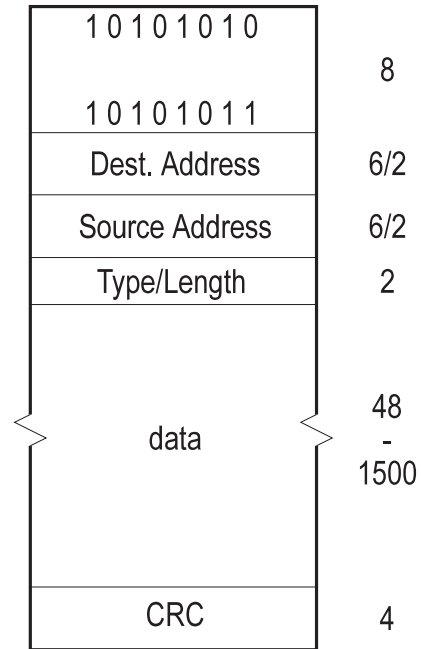
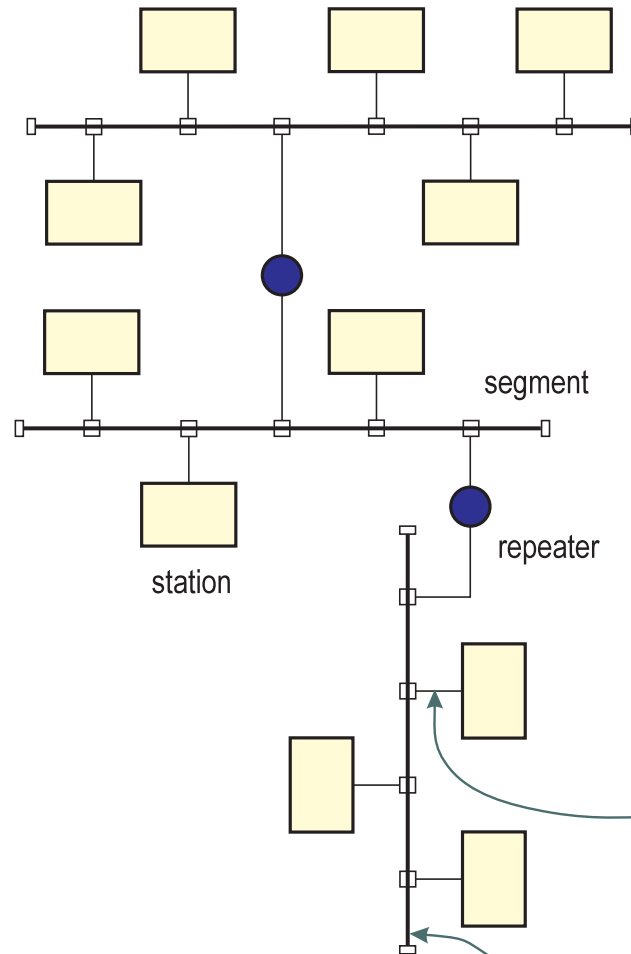

CSMA/DCR - binární výběr

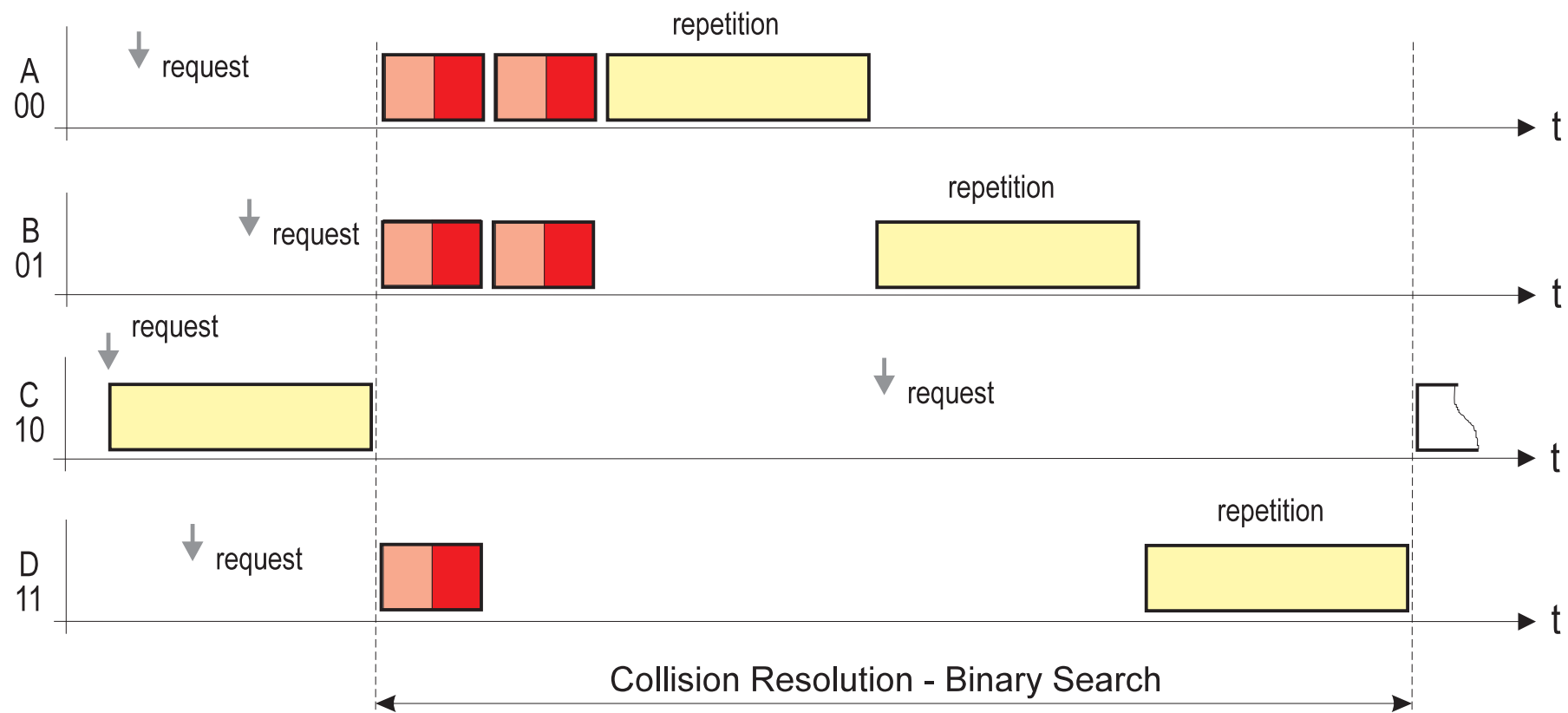

CSMA/DCR - virtuální log. kruh

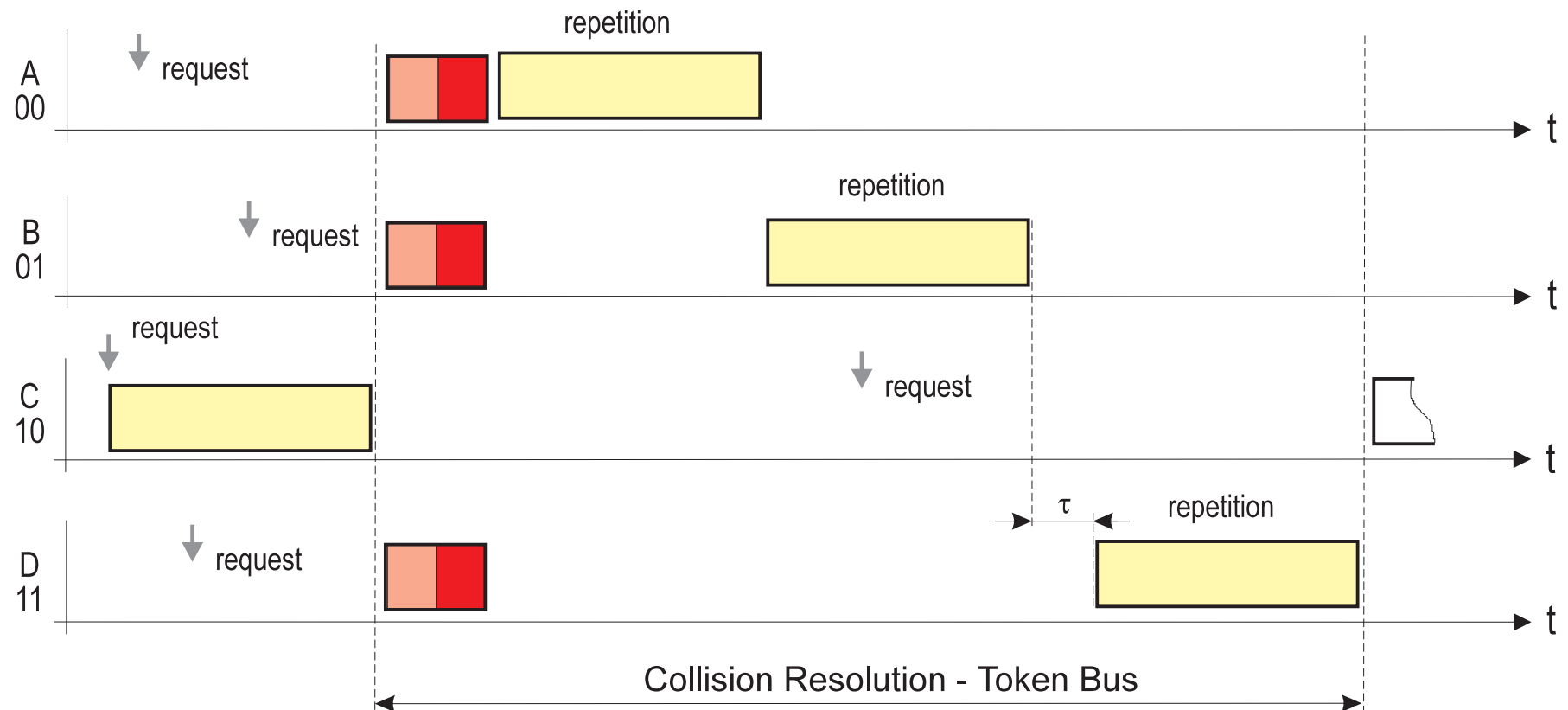

CSMA/CA

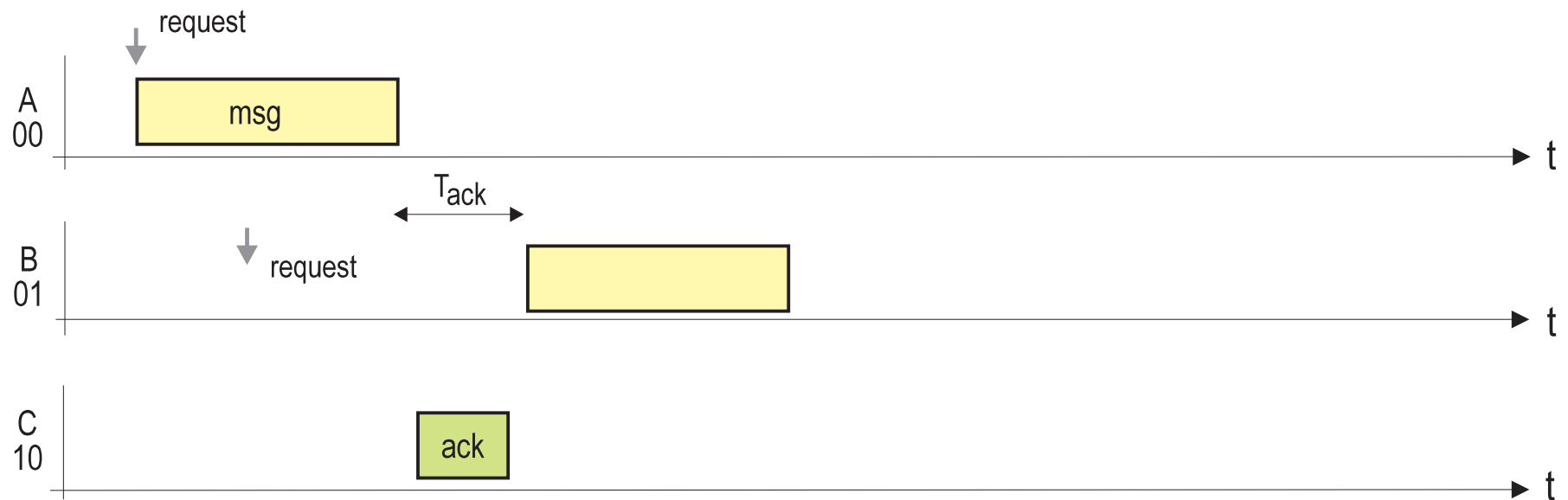

CSMA/CA - virtuální log. kruh

